



TERMA
SINCE 1990

Tune VWS

DRY MINT // 1800 — 490 // 50 mm connection valve + “Slim” thermostatic head

LUX

Tune VWD

DRY MINT // 1800 — 290 // 50 mm connection valve + “Slim” thermostatic head

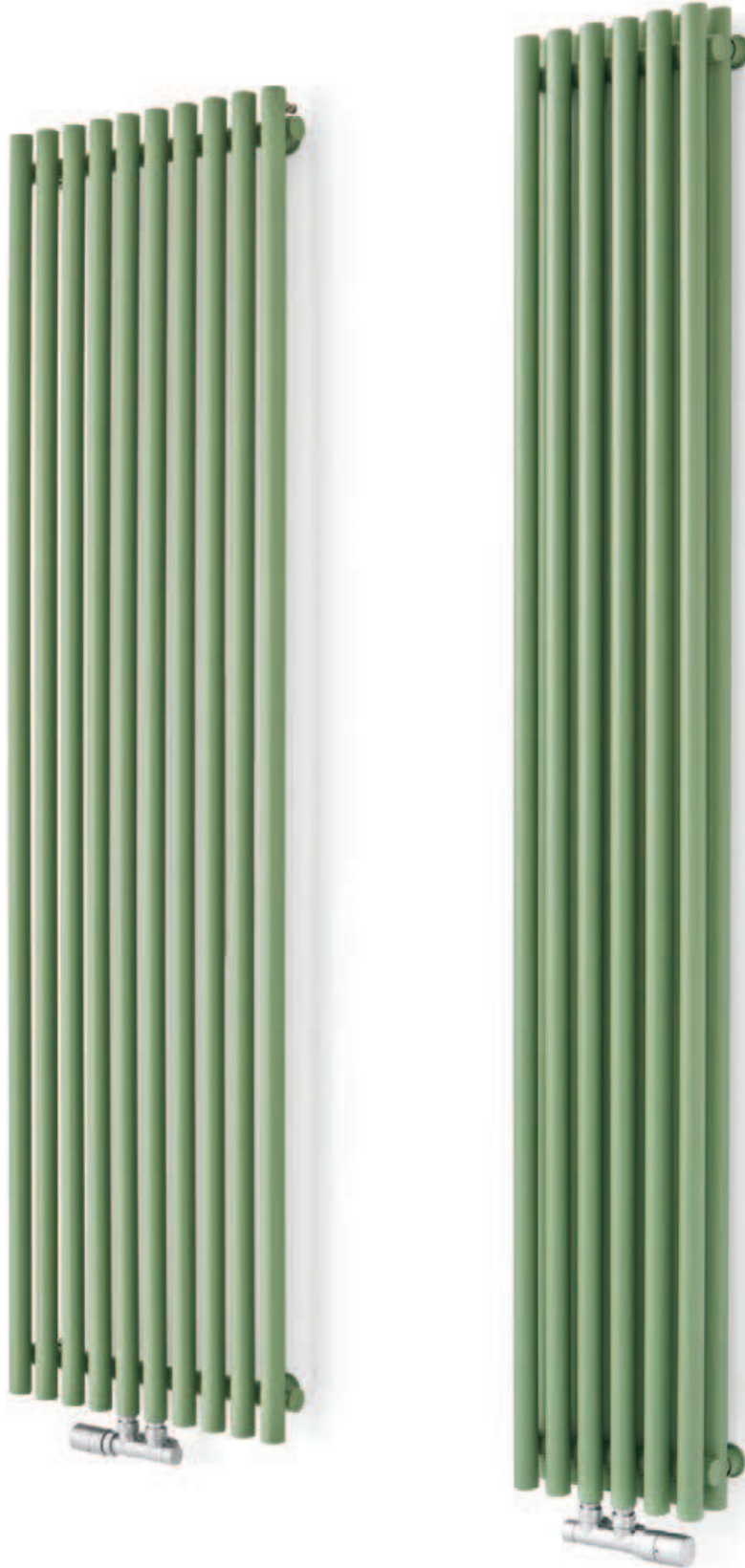

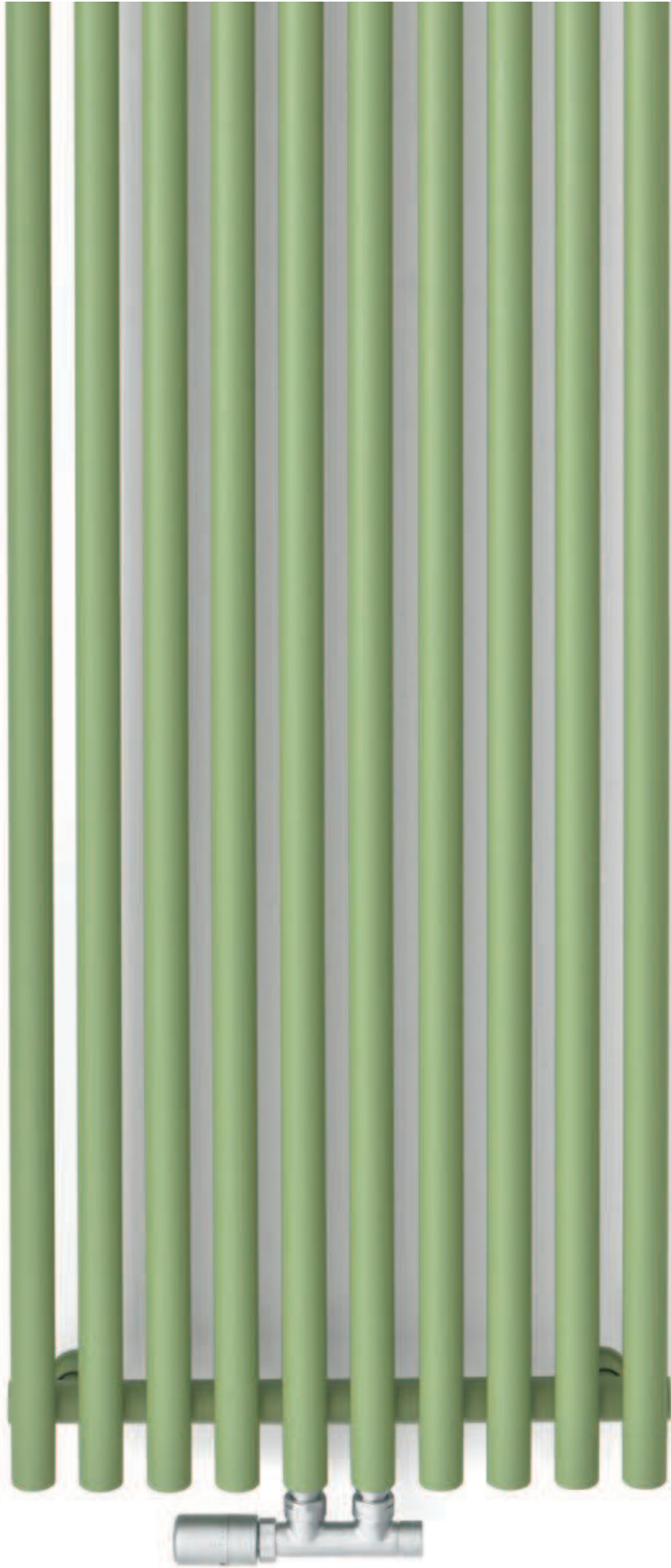

VWS



Standard connections:



Sizes available:

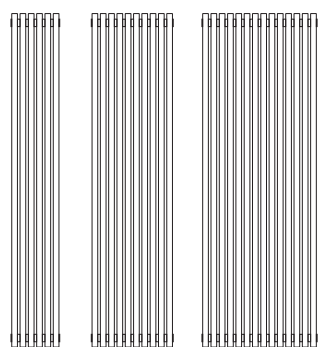

VWD







Standard connections:

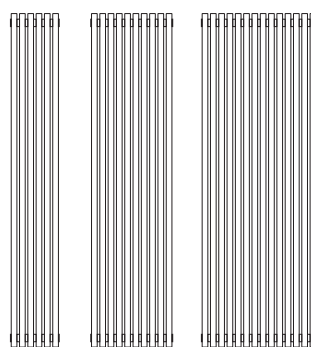

Sizes available:



A [mm]	B [mm]	C [mm]	C' [mm]		75/65/20 [W]	55/45/20 [W]	 [W]	D [mm]	E [mm]	F [mm]	 [dm³]	 [Kg]
VWS												
1800	290	50	250	RAL+TT	532	271	600	190	1700	50	7,8	10,8
1800	490	50	450	RAL+TT	958	489	1000	390	1700	50	13,1	17,8
1800	690	50	650	RAL+TT	1383	706	-	590	1700	50	18,3	24,9
VWD												
1800	290	50	250	RAL+TT	932	475	1000	190	1700	50	15,3	20,8
1800	490	50	450	RAL+TT	1550	791	-	390	1700	50	25,4	34,6
1800	690	50	650	RAL+TT	2169	1107	-	590	1700	50	35,6	48,3

Tune VWS

ZX

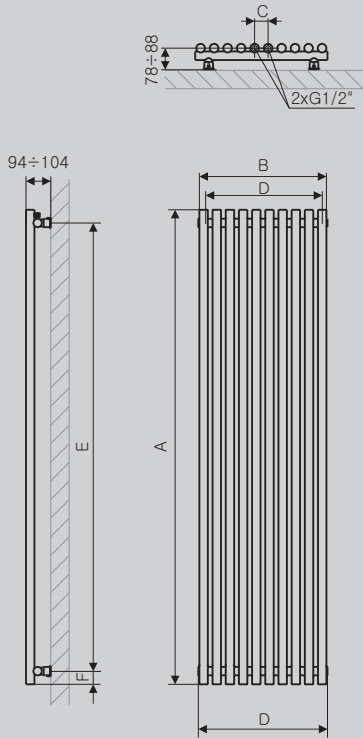

Z1

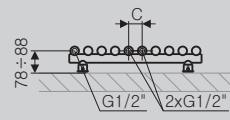

Z8

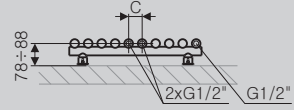

SX

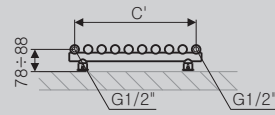

Tune VWD

ZX

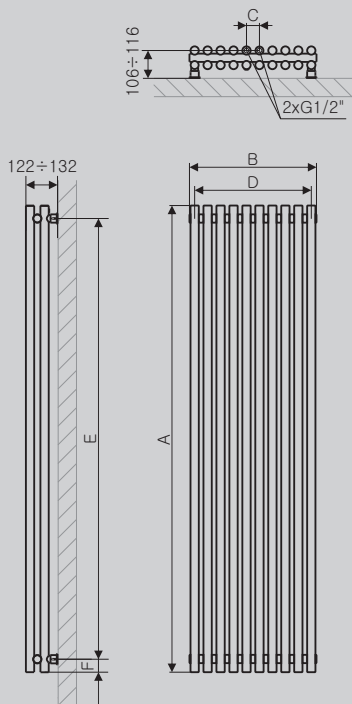

Z1

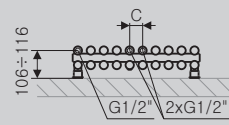

Z8

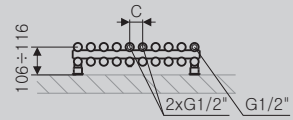

SX

