

linea ESSENTIAL



avila



ribeira



zamora



standard one



leon



divio



corner

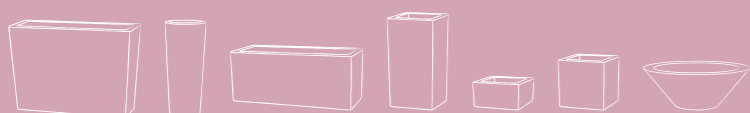

schio:
cassa alta, cono, cassa, cubo alto,
cubo basso, cubo, ciotola



veneto:
quadro, cassa, jardinera, tondo



pasubio:
alto, quadro, cassa



valentino



bassano





Avila

Superficie opaca
Matt finished
Surface opaque
Matt-Oberfläche

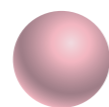

043
bianco/white
blanc/weiß



204
grigio seta/silk grey
grise soie/grauer Seide



201
cappuccino/cappuccino
cappuccino/cappuccino



032
antracite/anthracite
anthracite/anthrazitgrau



233
toffee/toffee
caramel/Toffee



234
malva/mauve
mauve/mauve



230
cielo/sky blue
ciel bleu/blauer Himmel



202
lavanda/lavender
lavande/lavendel



068
fucsia/fuchsia
fuchsia/fuchsiensfarbig



208
menta/mint
menthe/Minze



232
kiwi/kiwi
kiwi/Kiwi

colour on demand 030 050 011 049 210

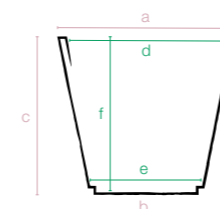

codice senza colore code without colour	Cm	dimensioni esterne external dimensions	dimensioni interne internal dimensions	litri liters	Confezione minima Minimum package	m ³	pezzi pallet pcs pallet	m ³
11 470 035	35	a:33 b:33 c:29	d:30 e:30 f:29	19	1 33x33x28h	0,03	66 80x120x115h	1,10
11 470 040	40	a:38 b:38 c:33	d:35 e:35 f:33	29	1 38x38x33h	0,04	54 80x120x115h	1,10
11 470 050	50	a:49 b:49 c:42	d:47 e:47 f:40	44	1 49x49x42h	0,10	32 80x120x220h	2,11



043
bianco/white
blanc/weiß

204
grigio seta/silk grey
grise soie/grauer Seide

201
cappuccino/cappuccino
cappuccino/cappuccino

032
antracite/anthracite
anthracite/anthrazitgrau

039
bronzo/bronze
bronze/bronze

233
toffee/toffee
caramel/Toffee

234
malva/mauve
mauve/mauve

230
cielo/sky blue
ciel bleu/blauer Himmel

202
lavanda/lavender
lavande/lavendel

068
fucsia/fuchsia
fuchsia/fuchsienfarbig

232
kiwi/kiwi
kiwi/Kiwi

208
menta/mint
menthe/Minze

Sottovasi a richiesta
saucers on demand
soucepe sur demand
Unter-setzer auf Anfrage
pagina 169

5 misure
5 sizes
5 mesures
5 Größen

colour on demand 030 050 211 049 210 203

Ribeira
Superficie opaca
Matt finished
Surface opaque
Matt-Oberfläche

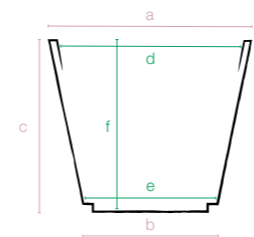

codice senza colore code without colour	Cm	dimensioni esterne external dimensions	dimensioni interne internal dimensions	litri liters	Confezione minima Minimum package	m ³	pezzi pallet pcs pallet	m ³
11 461 035	35	a33 b18,5 c29	d30 e18,5 f28	13	2	33x33x37h	0,04	63 80x120x115h 1,10
11 461 040	40	a38 b21,5 c35	d34,5 e21,5 f34	21	2	38x38x43h	0,06	114 80x120x230h 2,21
11 461 050	50	a49 b27,5 c43	d44,5 e27,5 f42	44	33	49x49x42h	0,10	64 100x120x230h 2,65
11 461 060	60	a57 b32 c49	d52 e32 f49	78	40	57x57x49h	0,15	28 80x120x220h 2,11
11 461 080	80	a77 b43 c65	d70 e43 f65	191	1	77x77x65h	0,38	10 80x80x220h 1,40



Zamora

Superficie opaca
Matt finished
Surface opaque
Matt-Oberfläche

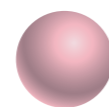

043
bianco/white
blanc/weiß



204
grigio seta/silk grey
grise soie/grauer Seide



201
cappuccino/cappuccino
cappuccino/cappuccino



068
fucsia/fuchsia
fuchsia/fuchsienfarbig



232
kiwi/kiwi
kiwi/Kiwi



202
lavanda/lavender
lavande/lavendel



032
antracite/anthracite
anthracite/anthrazitgrau



Sottovaso
pagina 169

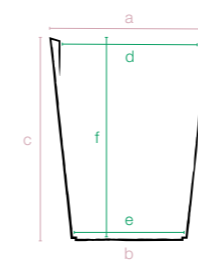

codice senza colore code without colour	Cm	dimensioni esterne external dimensions	dimensioni interne internal dimensions	litri liters	Confezione minima Minimum package	m ³	pezzi pallet pcs pallet	m ³
11 465 043	43	a33 b24 c42	d29 e24 f42	24	1 33x24x42h	0,03	98 80x120x225h	2,16
11 465 050	50	a39 b28,5 c50	d35 e28 f49	45	1 39x28,5x50h	0,30	60 80x120x215h	2,06
11 465 065	65	a49 b36 c66	d44 e35 f61	94	1 49x36x66h	0,10	21 80x120x210h	2,02

colour on demand 030 038 050 208 230 233 234 211 049 210 008



adatto anche per uso esterno
also suitable for outdoor use
également adapté pour une utilisation en extérieur
Outdoor geeignet



043
bianco/white
blanc/weiß



204
grigio seta/silk grey
grise soie/grauer Seide



201
cappuccino/cappuccino
cappuccino/cappuccino



030
anticato/light brown
marron clair/hellbraun



039
bronzo/bronze
bronze/bronze



050
rosso cardinale/cardinal red
rouge cardinal/scharlachrot



232
kiwi/kiwi
kiwi/Kiwi



202
lavanda/lavender
lavande/lavendel



032
antracite/anthracite
anthracite/anthrazitgrau



Sottovaso
pagina 169

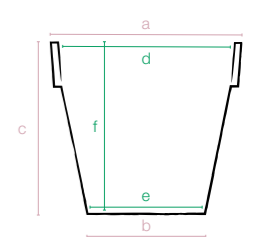

Standard One

Superficie opaca
Matt finished
Surface opaque
Matt-Oberfläche

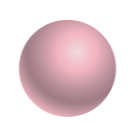

colour on demand 211 068 049 210 208 230 232 234 203

codice senza colore code without colour	Cm	dimensioni esterne external dimensions	dimensioni interne internal dimensions	litri liters	Confezione minima Minimum package	m ³	pezzi pallet pcs pallet	m ³
11 437 030	30	a30 b 18,5 c27	d26,5 e18,5 f27	11	4 30x30x48h	0,04	88 80x120x115h	1,10
11 437 040	40	a40 b 25 c35	d36 e25 f35	26	2 40x40x46h	0,07	48 80x120x112h	1,08
11 437 050	50	a50 b 31 c43	d44 e31 f43	48	2 50x50x58h	0,14	64 100x120x226h	2,71
11 437 060	60	a60 b 37 c54	d53 e37 f53	85	2 60x60x70h	0,25	22 80x120x215h	2,06
11 437 070	70	a70 b 43 c63	d61 e43 f62	133	1 70x70x63h	0,30	9 80x80x215h	1,38
11 437 080	80	a80 b 49 c72	d70 e49 f71	199	1 80x80x72h	0,46	8 80x80x220h	1,41
11 437 100	100	a100 b 61 c90	d88 e61 f90	396	1 100x100x90h	0,90	6 100x120x225h	2,70
11 437 120	120	a120 b 74 c108	d105 e74 f108	686	1 120x120x108h	1,29	4 120x120x215h	3,10
11 437 140	140	a140 b 86 c126	d123 e86 f126	1079	1 140x140x207h	2,46	3 140x140x207h	4,05



043
bianco/white
blanc/weiß



201
cappuccino/cappuccino
cappuccino/cappuccino



032
antracite/anthracite
anthracite/anthrazitgrau

Leon

Superficie opaca
Matt finished
Surface opaque
Matt-Oberfläche

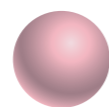

colour on demand 090 050 211 202 068 208 232 208 230 233 234 204 049 210 038

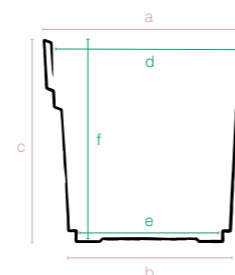

codice senza colore code without colour	Cm	dimensioni esterne external dimensions			dimensioni interne internal dimensions			litri liters	Confezione minima Minimum package	m ³	pezzi pallet pcs pallet	m ³
11 471 035	35	a33	b33	c33	d29	e29	f33	9	1 33x33x33h	0,03	63	80x120x115h 1,10
11 471 040	40	a38	b38	c38	d35	e35	f38	15	1 38x38x38h	0,05	48	80x120x115h 1,10



Divio indoor



043
bianco/white
blanc/weiß



201
cappuccino/cappuccino
cappuccino/cappuccino



210
grafite/graphite
graphite/graphit



232
kiwi/kiwi
kiwi/Kiwi

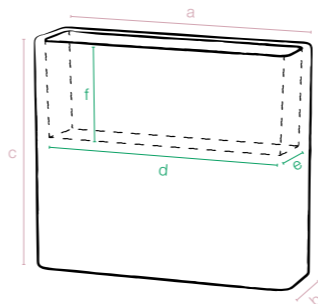

colour on demand 030 050 211 202 068 208 230 233 234 204 049 032 039 203

codice senza colore code without colour	Cm	dimensioni esterne external dimensions	dimensioni interne internal dimensions	litri liters	Confezione minima Minimum package	m ³	pezzi pallet pcs pallet	m ³
11 466 080	80	a:90 b:27 c:77	d:85 e:21 f:33	59	1 91x28x79h	0,2	8 80x120x201h	1,93

Corner indoor



043
bianco/white
blanc/weiß



201
cappuccino/cappuccino
cappuccino/cappuccino



210
grafite/graphite
graphite/graphit



232
kiwi/kiwi
kiwi/Kiwi

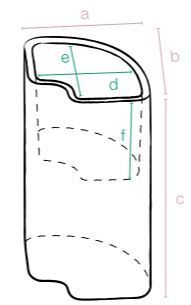

colour on demand 030 050 211 202 068 208 230 233 234 204 049 032 039 203

codice senza colore code without colour	Cm	dimensioni esterne external dimensions	dimensioni interne internal dimensions	litri liters	Confezione minima Minimum package	m ³	pezzi pallet pcs pallet	m ³
11 467 080	80	a:39 b:39 c:77	d:22 e:34 f:33	26	1 40x40x79h	0,1	15 80x120x213h	2,04

Divio e Corner

Superficie opaca
Matt finished
Surface opaque
Matt-Oberfläche



Divio e Corner si prestano molto bene per organizzare gli spazi
 DIVIO and CORNER lend very well to organize spaces
 Divio et Corner se prêtent très bien pour l'organisation des espaces
 Divio und Corner sind ideal für die Teilung der Räume

Divio + Corner
componibili
modular
modulable
zusammensetzbar

Divio e Corner
indoor
outdoor

permettono diverse combinazioni
 allow various combinations
 ils permettent différentes combinaisons
 Divio und Corner ermöglichen viele Zusammenstellungen

in base all'ambiente
 depending on the environment
 en fonction de l'environnement
 nach dem Raum

e alla vostra fantasia
 and to your imagination
 et à votre imagination
 und Ihrer Fantasie

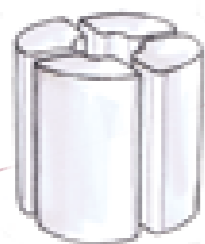
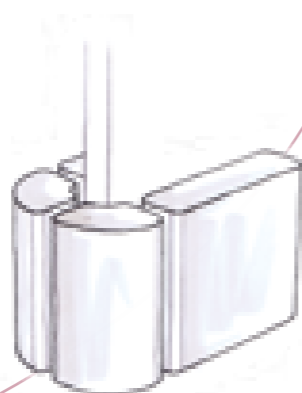
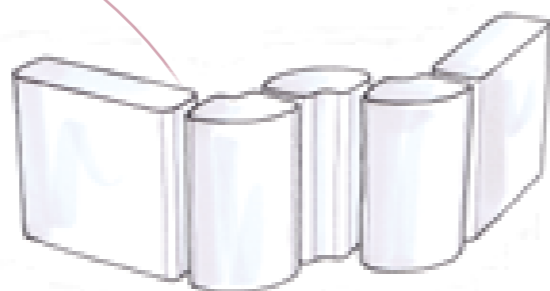
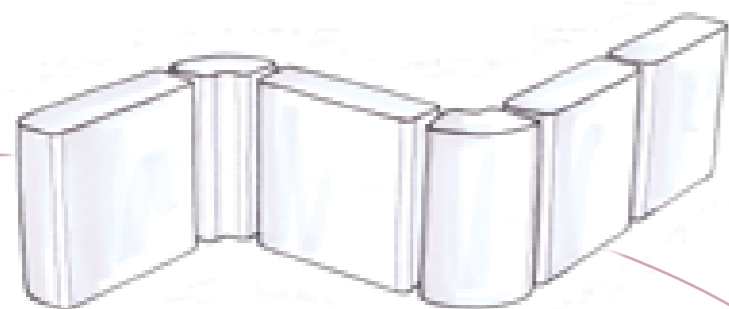

sabbia
 sand
 sable
 Sand

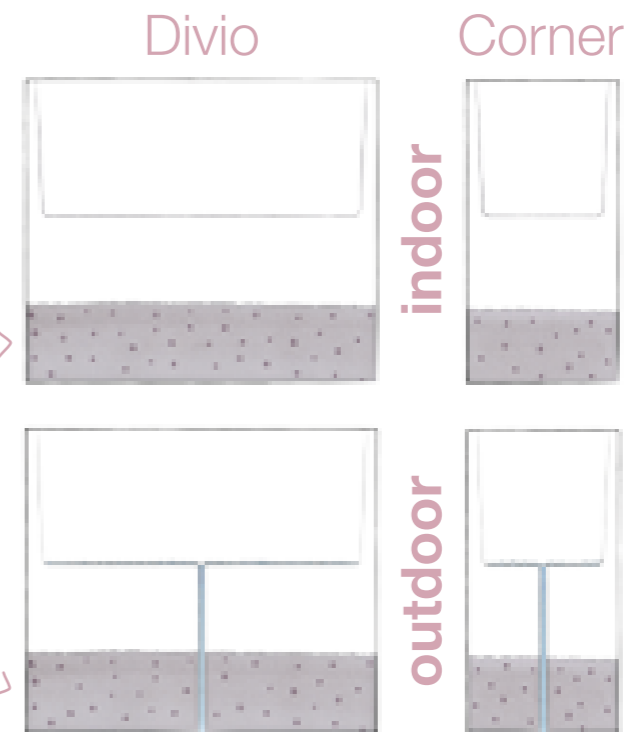

foro di drenaggio per l'acqua in eccesso
 drainage bore for water's excess
 trou de drainage pour l'eau en excès
 Entwässerungsloch

Divio outdoor

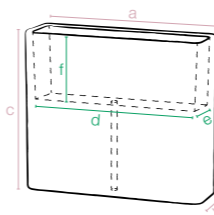

colour on demand 030 050 211 202 068 208 230 233 234 204 049 032 039 203

codice senza colore code without colour	Cm	dimensioni esterne external dimensions	dimensioni interne internal dimensions	litri liters	Confezione minima Minimum package	m ³	pezzi pallet pcs pallet	m ³
15 466 080	80	a:90 b:27 c:77	d:85 e:21 f:33	59	1 91x28x79h	0,2	8 80x120x201h	1,93

Corner outdoor

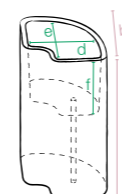

colour on demand 030 050 211 202 068 208 230 233 234 204 049 032 039 203

codice senza colore code without colour	Cm	dimensioni esterne external dimensions	dimensioni interne internal dimensions	litri liters	Confezione minima Minimum package	m ³	pezzi pallet pcs pallet	m ³
15 467 080	80	a:39 b:39 c:77	d:22 e:34 f:33	26	1 40x40x79h	0,1	15 80x120x213h	2,04



Schio

cassa alta



Superficie opaca
Matt finished
Surface opaque
Matt-Oberfläche



Schio

cono

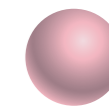

Superficie opaca
Matt finished
Surface opaque
Matt-Oberfläche

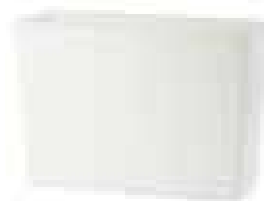

043

bianco/white
blanc/weiß



201

cappuccino/cappuccino
cappuccino/cappuccino



032

antracite/anthracite
anthracite/anthrazitgrau



050

rosso cardinale/cardinal red
rouge cardinal/scharlachrot



043

bianco/white
blanc/weiß

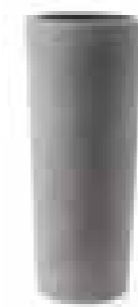

201

cappuccino/cappuccino
cappuccino/cappuccino



032

antracite/anthracite
anthracite/anthrazitgrau



050

rosso cardinale/cardinal red
rouge cardinal/scharlachrot



039

bronzo/bronze
bronze/bronze

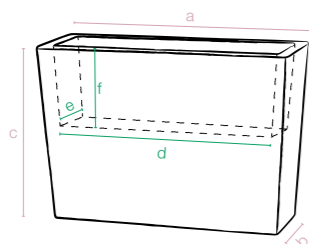

colour on demand 030 211 202 068 203 232 208 230 233 234 204 049 210 039

codice senza colore code without colour	Cm	dimensioni esterne external dimensions			dimensioni interne internal dimensions			litri liters	Confezione minima Minimum package	m ³	pezzi pallet pcs pallet	m ³
11 428 050	50	a50	b36	c70	d42	e28	f70	31	1 50x40x70h	0,14	12 80x120x222h	2,13
11 428 100	100	a100	b36	c70	d91	e28	f100	70	1 100x40x70h	0,28	6 80x120x222h	2,13

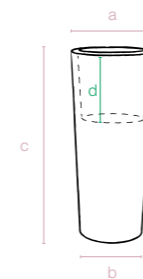
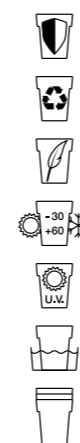

colour on demand 030 211 202 068 203 232 208 230 233 234 204 049 210

codice senza colore code without colour	Cm	dimensioni dimensions				litri liters	Confezione minima Minimum package	m ³	pezzi pallet pcs pallet	m ³	accessori accessories
11 424 070	70	a30	b23	c68	d20	8	1 30x30x68h	0,06	24 80x120x225h	2,16	
11 424 090	90	a40	b29,5	c90	d26	26	1 40x40x90h	0,14	12 80x120x195h	1,87	
11 424 110	110	a45	b34,5	c110	d28	35	1 45x45x110h	0,22	12 80x120x236h	2,27	
11 424 145	145	a55	b44,5	c145	d31	46	1 55x55x145h	0,43	4 100x120x160h	1,92	





Schio

cassa



Superficie opaca
Matt finished
Surface opaque
Matt-Oberfläche

Schio

cubo alto

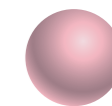

Superficie opaca
Matt finished
Surface opaque
Matt-Oberfläche

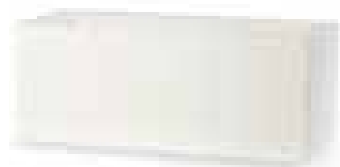

043

bianco/white
blanc/weiß

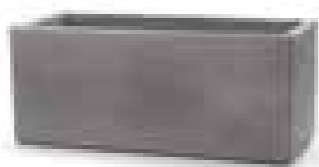

201

cappuccino/cappuccino
cappuccino/cappuccino



032

antracite/anthracite
anthracite/anthrazitgrau



050

rosso cardinale/cardinal red
rouge cardinal/scharlachrot



039

bronzo/bronze
bronze/bronze



043

bianco/white
blanc/weiß

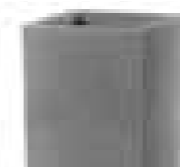

201

cappuccino/cappuccino
cappuccino/cappuccino



032

antracite/anthracite
anthracite/anthrazitgrau



050

rosso cardinale/cardinal red
rouge cardinal/scharlachrot



039

bronzo/bronze
bronze/bronze

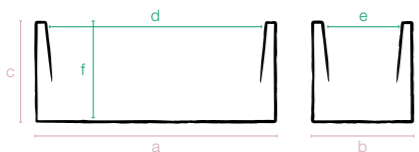

colour on demand 030 211 202 068 203 232 208 230 233 234 204 049 210

codice senza colore code without colour	Cm	dimensioni esterne external dimensions			dimensioni interne internal dimensions			litri liters	Confezione minima Minimum package	m ³	pezzi pallet pcs pallet	m ³
11 427 060	60	a60	b25	c25	d54	e20	f25	26	2 60x25x50h	0,07	24 80x120x115h	1,10
11 427 080	80	a80	b30	c30	d73	e24	f30	51	2 80x30x30h	0,07	28 80x120x222h	2,13
11 427 100	100	a100	b40	c40	d90	e30	f40	108	1 100x40x40h	0,16	10 80x120x210h	2,52
11 427 120	120	a115	b50	c50	d103	e38	f50	195	1 115x50x50h	0,28	8 100x120x220h	2,53

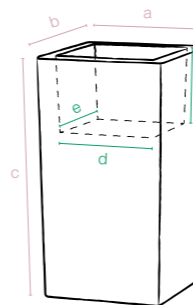

colour on demand 030 211 202 068 203 232 208 230 233 234 204 049 210

codice senza colore code without colour	Cm	dimensioni esterne external dimensions			dimensioni interne internal dimensions			litri liters	Confezione minima Minimum package	m ³	pezzi pallet pcs pallet	m ³	accessori accessories
11 426 080	80	a40	b40	c80	d30	e30	f20	31	1 40x40x80h	0,07	15 80x120x215h	1,10	

Fix Wall
pagina 198



Schio

cubo basso



Superficie opaca
Matt finished
Surface opaque
Matt-Oberfläche

Schio

cubo

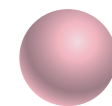

Superficie opaca
Matt finished
Surface opaque
Matt-Oberfläche



043

bianco/white
blanc/weiß

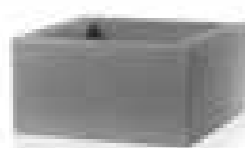

201

cappuccino/cappuccino
cappuccino/cappuccino



032

antracite/anthracite
anthracite/anthrazitgrau



050

rosso cardinale/cardinal red
rouge cardinal/scharlachrot



039

bronzo/bronze
bronze/bronze



043

bianco/white
blanc/weiß

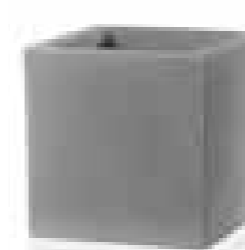

201

cappuccino/cappuccino
cappuccino/cappuccino



032

antracite/anthracite
anthracite/anthrazitgrau

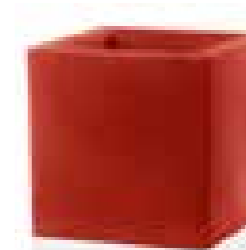

050

rosso cardinale/cardinal red
rouge cardinal/scharlachrot



039

bronzo/bronze
bronze/bronze

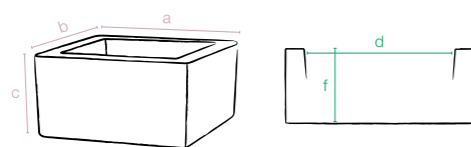
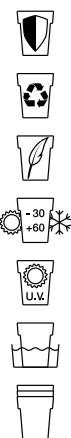

colour on demand 030 211 202 068 203 232 208 230 233 234 204 049 210

codice senza colore code without colour	Cm	dimensioni esterne external dimensions			dimensioni interne internal dimensions			litri liters	Confezione minima Minimum package	m ³	pezzi pallet pcs pallet	m ³
11 456 050	50	a50	b50	c20	d40	e40	f19	26	1 50x50x20h	0,05	14 80x120x115h	0,55

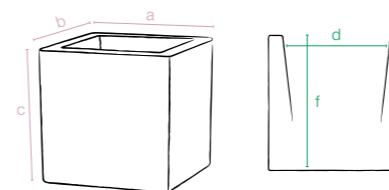
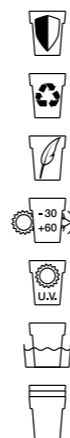

colour on demand 030 211 202 068 203 232 208 230 233 234 204 049 210

codice senza colore code without colour	Cm	dimensioni esterne external dimensions			dimensioni interne internal dimensions			litri liters	Confezione minima Minimum package	m ³	pezzi pallet pcs pallet	m ³
11 425 025	25	a25	b25	c25	d19,5	e19,5	f24	9	1 25x25x25h	0,01	48 80x120x115h	0,55
11 425 030	30	a30	b30	c30	d23,5	e23,5	f28	15	1 30x30x30h	0,02	24 80x120x115h	1,10
11 425 040	40	a40	b40	c40	d30	e30	f38	34	1 40x40x40h	0,06	12 80x120x92h	0,88
11 425 050	50	a50	b50	c50	d38	e38	f38	55	1 50x50x50h	0,12	8 100x120x112h	1,34
11 425 060	60	a58	b58	c58	d45	e45	f58	117	1 58x58x58h	0,19	6 80x120x200h	1,92

Schio family
componibile
 modular
 modulaire
 zusammensetzbar

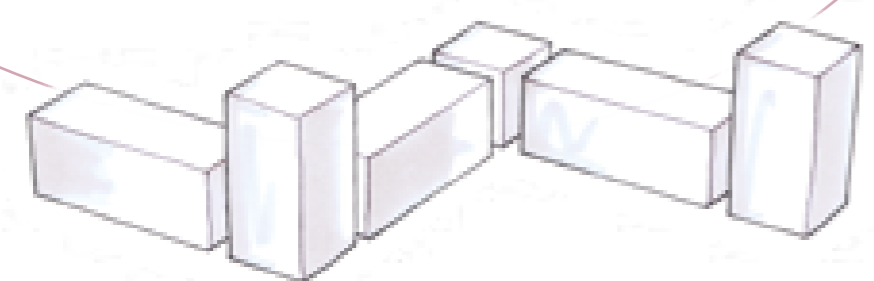
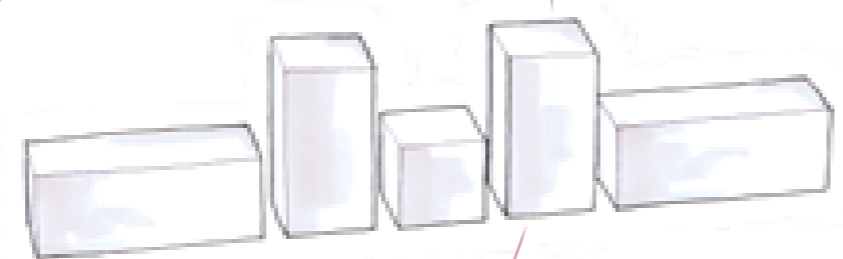
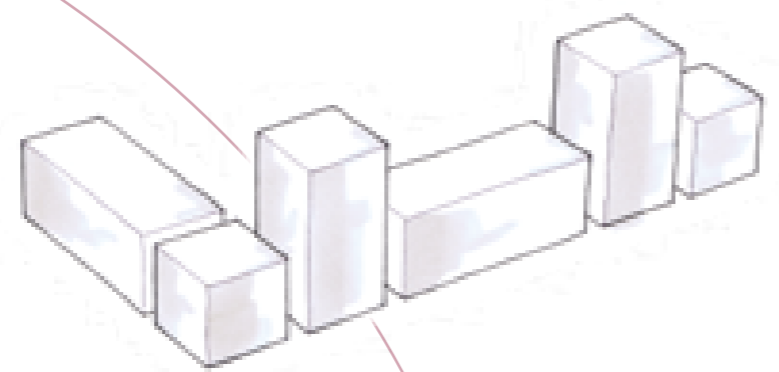
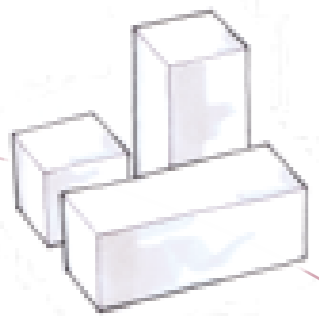

Schio cubo, Schio cubo alto e Schio cassa si prestano molto bene per organizzare gli spazi
 Schio cubo, Schio cubo alto and Schio cassa lend very well to organize spaces
 Schio Cubo, Cubo Alto et Cassa se prêtent très bien pour l'organisation des espaces
 Schio Cubo, Schio Cubo Alto und Schio Cassa sind ideal für die Organization der Räume



Schio
 ciotola

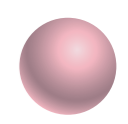

Superficie opaca
 Matt finished
 Surface opaque
 Matt-Oberfläche



043
 bianco/white
 blanc/weiß



201
 cappuccino/cappuccino
 cappuccino/cappuccino



032
 antracite/anthracite
 anthracite/anthrazitgrau



050
 rosso cardinale/cardinal red
 rouge cardinal/scharlachrot



039
 bronzo/bronze
 bronze/bronze



030
 anticato/light brown
 marron clair/hellbraun

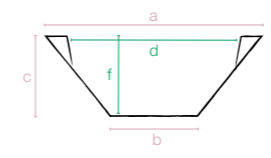
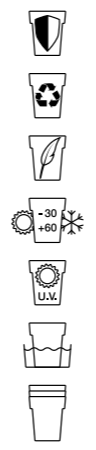

colour on demand 211 202 068 203 232 208 230 233 234 204 049 210

codice senza colore code without colour	Cm	dimensioni esterne external dimensions			dimensioni interne internal dimensions		litri liters	Confezione minima Minimum package	m ³	pezzi pallet pcs pallet	m ³
11 433 060	60	a60	b24,5	c22	d48	e21	22	2 60x60x30h	0,10	26	80x120x113h 1,08
11 433 080	80	a80	b32,5	c29	d64,5	e28	54	2 80x80x39h	0,25	10	80x80x113h 0,72
11 433 100	100	a100	b40	c37	d80	e36	106	1 100x100x37h	0,37	7	100x120x113h 1,36



quadro Veneto



Superficie opaca
Matt finished
Surface opaque
Matt-Oberfläche

cassa Veneto



Superficie opaca
Matt finished
Surface opaque
Matt-Oberfläche



043

bianco/white
blanc/weiß



201

cappuccino/cappuccino
cappuccino/cappuccino



039

bronzo/bronze
bronze/bronze



032

antracite/anthracite
anthracite/anthrazitgrau



Sottovaso
pagina 169

colour on demand

codice senza colore code without colour	Cm	dimensioni esterne external dimensions			dimensioni interne internal dimensions			litri liters		Confezione minima Minimum package	m ³	pezzi pallet pcs pallet		m ³
11 407 035	35	a:29	b:29	c:36	d:25	e:25	f:36	17	30	2 29x29x57h	0,04	32	80x120x115h	1,10
11 407 040	40	a:33	b:33	c:41	d:28,5	e:28,5	f:41	25	30	2 33x33x66h	0,07	48	80x120x230h	2,21
11 407 050	50	a:40	b:40	c:50	d:34	e:34	f:50	44	30	2 40x40x78h	0,12	42	80x120x228h	2,19
11 407 060	60	a:49	b:49	c:61	d:42	e:42	f:61	83	36	1 49x49x61h	0,14	20	100x120x230h	2,65
11 407 065	65	a:40	b:40	c:65	d:34	e:34	f:65	56	30	2 40x40x107h	0,17	30	80x120x238h	2,28



043

bianco/white
blanc/weiß



201

cappuccino/cappuccino
cappuccino/cappuccino



039

bronzo/bronze
bronze/bronze

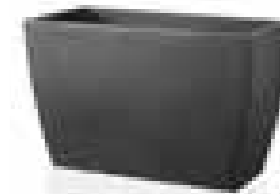

032

antracite/anthracite
anthracite/anthrazitgrau

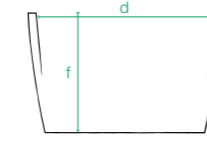
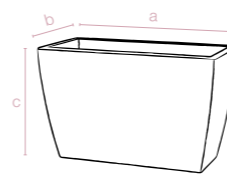

colour on demand

codice senza colore code without colour	Cm	dimensioni esterne external dimensions			dimensioni interne internal dimensions			litri liters	Confezione minima Minimum package	m ³	pezzi pallet pcs pallet		m ³
11 438 080	80	a:80	b:40	c:50	d:74	e:35	f:50	169	2 80x40x80h	0,25	18	80x120x228h	2,19

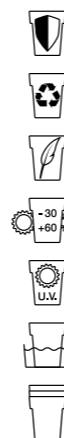
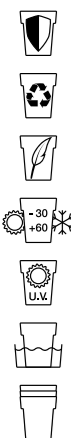

jardinera Veneto



Superficie opaca
Matt finished
Surface opaque
Matt-Oberfläche



tondo Veneto

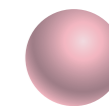

Superficie opaca
Matt finished
Surface opaque
Matt-Oberfläche



043

bianco/white
blanc/weiß



201

cappuccino/cappuccino
cappuccino/cappuccino



032

antracite/anthracite
anthracite/anthrazitgrau



039

bronzo/bronze
bronze/bronze

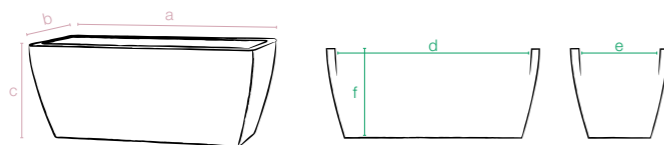

colour on demand 030 211 202 068 050 203 232 208 230 233 234 204 049 210

codice senza colore code without colour	Cm	dimensioni esterne external dimensions			dimensioni interne internal dimensions			litri liters	Confezione minima Minimum package	m ³	pezzi pallet pcs pallet	m ³
11 460 058	58	a:58	b:29	c:25	d:54	e:25	f:25	43	2 58x29x41h	0,06	52 80x120x230h	2,21
11 460 066	66	a:66	b:33	c:28	d:62	e:29	f:28	68	2 66x33x46h	0,10	33 80x120x230h	2,21
11 460 080	80	a:79	b:39	c:33	d:73	e:33	f:33	107	2 79x39x54h	0,16	27 80x120x230h	2,21



043

bianco/white
blanc/weiß



201

cappuccino/cappuccino
cappuccino/cappuccino



032

antracite/anthracite
anthracite/anthrazitgrau



039

bronzo/bronze
bronze/bronze

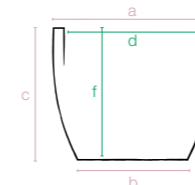

colour on demand 030 211 202 068 050 203 232 208 230 233 234 204 049 210

codice senza colore code without colour	Cm	dimensioni esterne external dimensions			dimensioni interne internal dimensions			litri liters	Confezione minima Minimum package	m ³	pezzi pallet pcs pallet	m ³
11 448 032	32	a:32	b:21	c:27	d:26	e:25	f:25	11	2 32x32x48h	0,04	64 80x120x232h	2,23
11 448 042	42	a:42	b:28	c:35	d:35	e:33	f:33	26	2 42x42x63h	0,11	36 80x120x222h	2,13
11 448 052	52	a:52	b:36	c:43	d:43	e:40	f:40	49	2 52x52x80h	0,21	15 80x120x227h	2,72
11 448 062	62	a:62	b:36	c:50	d:50	e:44	f:44	64	2 62x62x88h	0,33	10 80x120x207h	1,99



Pasubio quadro



Superficie opaca
Matt finished
Surface opaque
Matt-Oberfläche

Pasubio cassa

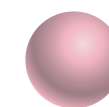

Superficie opaca
Matt finished
Surface opaque
Matt-Oberfläche



201

cappuccino/cappuccino
cappuccino/cappuccino



032

antracite/anthracite
anthracite/anthrazitgrau



201

cappuccino/cappuccino
cappuccino/cappuccino



032

antracite/anthracite
anthracite/anthrazitgrau

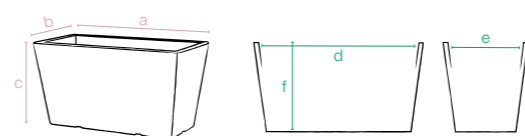
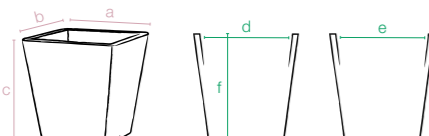
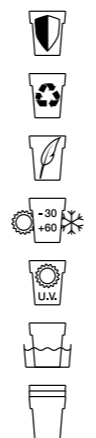
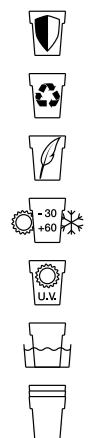

colour on demand 043 030 050 211 202 068 203 232 208 230 233 234 204 049 210 039

colour on demand 043 030 050 211 202 068 203 232 208 230 233 234 204 049 210 039

codice senza colore code without colour	Cm	dimensioni esterne external dimensions	dimensioni interne internal dimensions	litri liters	Confezione minima Minimum package	pezzi pallet pcs pallet	accessori accessories
11 463 040	40	a40 b40 c42	d34 e34 f42	40	2 40x40x71h	0,11 24 80x120x210h	2,02

codice senza colore code without colour	Cm	dimensioni esterne external dimensions	dimensioni interne internal dimensions	litri liters	Confezione minima Minimum package	pezzi pallet pcs pallet	accessori accessories
11 464 080	80	a80 b40 c42	d74 e34 f42	66	2 80x40x71h	0,22 12 80x120x112h	1,08

Fix Ground
Fix Wall
pagina198

Pasubio Alto,
Quadro e Cassa
componibili
modular
modulable
zusammensetzbar



Pasubio
alto

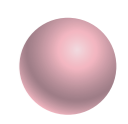

Superficie opaca
Matt finished
Surface opaque
Matt-Oberfläche

Pasubio Alto, Pasubio Quadro e Pasubio Cassa si prestano molto bene per organizzare gli spazi
Pasubio Quadro and Pasubio Cassa lend very well to organize spaces
Pasubio Quadro et Pasubio Cassa se prêtent très bien pour l'organisation des espaces
Pasubio Quadro und Pasubio Cassa sind ideal für die Organization der Räume

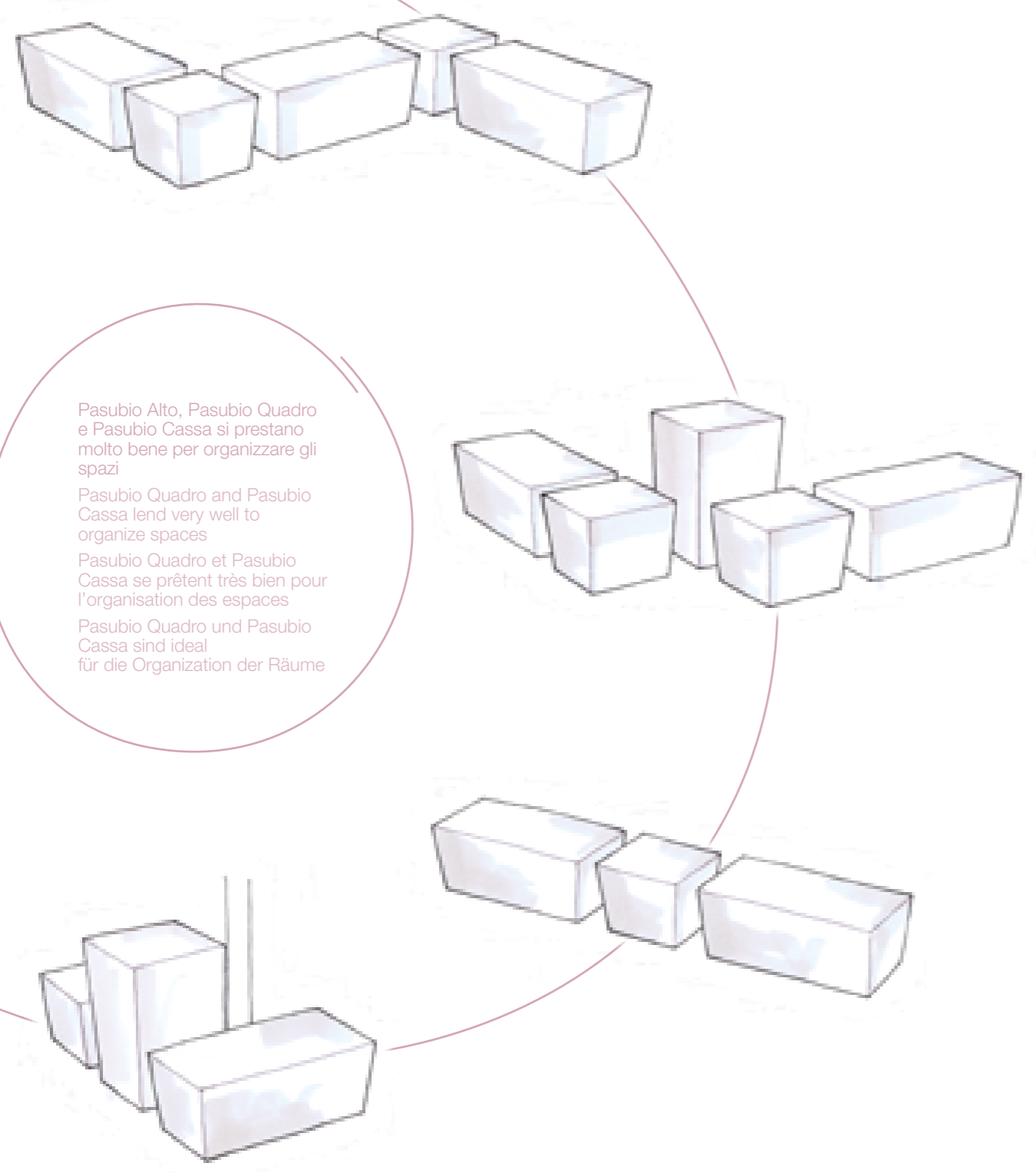

201
cappuccino/cappuccino
cappuccino/cappuccino



032
antracite/anthracite
anthracite/anthrazitgrau

-
-
-
-
-
-
-

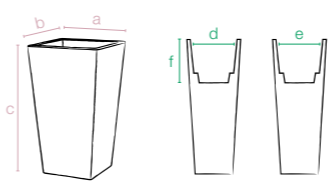

colour on demand 049 030 050 211 202 068 203 232 208 230 233 234 204 049 210 039

codice senza colore code without colour	Cm	dimensioni esterne external dimensions			dimensioni interne internal dimensions			litri liters	Confezione minima Minimum package	m ²	pezzi pallet pcs pallet	m ²	accessori accessories
11 462 070	70	a40	b40	c68	d34	e34	f25	31	1 40x40x70h	0,11	24 80x120x210h	2,02	
11 462 100	100	a40	b40	c100	d34	e34	f25	32	1 40x40x100h	0,16	12 80x120x212h	2,04	

Fix Ground
Fix Wall
pagina 198

Valentino



Superficie opaca
Matt finished
Surface opaque
Matt-Oberfläche



Bassano

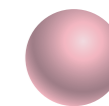

Superficie opaca
Matt finished
Surface opaque
Matt-Oberfläche



043

bianco/white
blanc/weiß



201

cappuccino/cappuccino
cappuccino/cappuccino



032

antracite/anthracite
anthracite/anthrazitgrau



050

rosso cardinale/cardinal red
rouge cardinal/scharlachrot



043

bianco/white
blanc/weiß



201

cappuccino/cappuccino
cappuccino/cappuccino



032

antracite/anthracite
anthracite/anthrazitgrau



050

rosso cardinale/cardinal red
rouge cardinal/scharlachrot

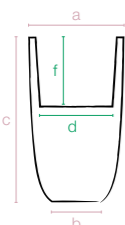
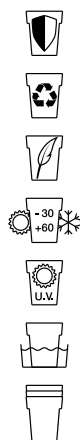

colour on demand 030 211 202 068 203 232 230 233 234 204 048 210 039

codice senza colore code without colour	Cm	dimensioni esterne external dimensions			dimensioni interne internal dimensions		litri liters	Confezione minima Minimum package	m ³	pezzi pallet pcs pallet	m ³	accessori accessories
11 432 050	50	a34	b21	c50	d26	f22	10	2 34x68x50h	0,11	16 80x120x112h	1,08	
11 432 070	70	a42	b25	c70	d32	f28	17	1 42x42x70h	0,12	18 80x120x226h	2,17	
11 432 090	90	a52	b30	c90	d40	f28	29	1 52x52x90h	0,24	8 100x120x195h	2,34	

Fix Ground
Fix Wall
pagina 198

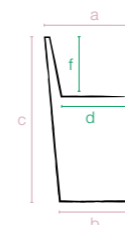

colour on demand 030 211 202 068 203 232 230 233 234 204 048 210 039

codice senza colore code without colour	Cm	dimensioni esterne external dimensions			dimensioni interne internal dimensions		litri liters	Confezione minima Minimum package	m ³	pezzi pallet pcs pallet	m ³	accessori accessories
11 423 060	60	a36	b29	c60	d27	f20	1	45x45x60h	0,12	24 80x120x202h	1,94	
11 423 100	100	a48	b35	c100	d35	f34	1	60x60x100h	0,36	6 100x120x165h	1,58	

Fix Ground
Fix Wall
pagina 198



Fix Ground round

ACCESSORI: articoli molto semplici ma di sicuro utilizzo. Fissati a una parete o sul pavimento riducono notevolmente le possibilità di ribaltamento accidentale.

ACCESSORIES: items very simple but certainly used. Attached to a wall or lying on the floor they reduced significantly the possibility of rollover accident.

ACCESSOIRES: des articles très simples mais sûrement utiles. Fixés au mur ou au plancher, ils réduisent considérablement le risque de renversement accidentel.

ZUBEHÖR: diese Artikel sind sehr einfach aber ganz sicherlich nützlich. Festgeschraubt auf einer Wand oder auf dem Boden, reduzieren sie stark das Umkippenrisiko.

codice senza colore code without colour	Cm	dimensioni dimensions	Confezione minima Minimum package	 m³
10 903 041	41	a41 b0,5	2 42x42x4h	0,01
10 903 048	48	a48 b0,5	2 50x50x4h	0,01
10 903 060	60	a60 b0,5	2 62x62x4h	0,01

Fix Ground square

codice senza colore code without colour	Cm	dimensioni dimensions	Confezione minima Minimum package	 m³
10 908 039	39	a39 b0,5	2 40x40x4h	0,01



Fix Wall

codice senza colore code without colour	Cm	dimensioni dimensions	Confezione minima Minimum package	 m³
10 904 007	7	a25 b0,5	2 25x15x5h	0,002

Rotelle standard S3-3



codice senza colore code without colour	Confezione minima Minimum package	 m³
10 902 004	4x12 15x15x10h	0,002