



**TERMA**  
SINCE 1990

# Delfin

CALIFORNIA BEIGE // 1800 — 580 // 50 mm connection valve + “Slim” thermostatic head

LUX





Radiator available in the following heights:  
440, 540 and 640

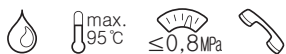

Standard connections:

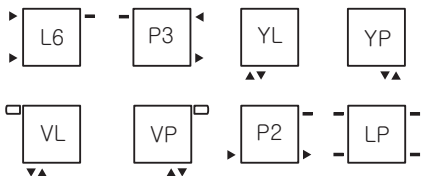

Sizes available:

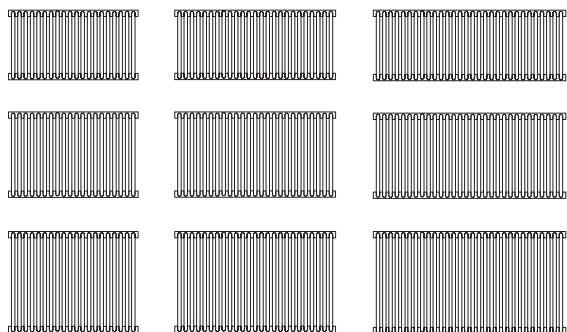

Radiator available in the following heights:  
1800 and 2000

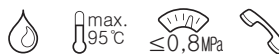

Standard connections:

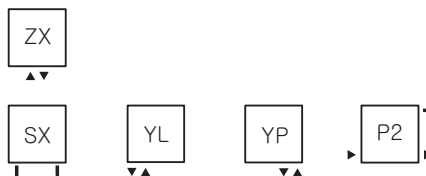

Sizes available:

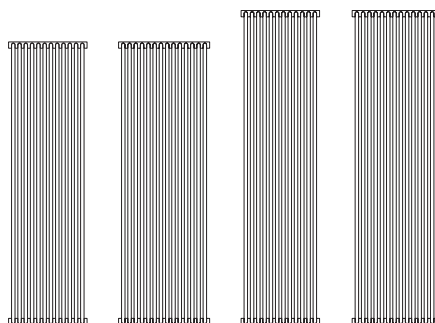

A	B	C	C'	C''		75/65/20	55/45/20		D	E	F		
[mm]	[mm]	[mm]	[mm]	[mm]		[W]	[W]	[W]	[mm]	[mm]	[mm]	[dm³]	[Kg]
440	820	400	50	-	RAL+TT	705	360	-	710	400	21	6,4	13,8
440	1020	400	50	-	RAL+TT	885	452	-	710	400	21	8,0	17,1
440	1220	400	50	-	RAL+TT	1061	541	-	710	400	21	12,8	27,3
540	820	500	50	-	RAL+TT	846	431	-	910	500	21	7,6	16,3
540	1020	500	50	-	RAL+TT	1057	539	-	910	500	21	9,5	20,4
540	1220	500	50	-	RAL+TT	1264	645	-	910	500	21	11,4	24,4
640	820	600	50	-	RAL+TT	986	503	-	1110	600	21	8,8	18,9
640	1020	600	50	-	RAL+TT	1233	629	-	1110	600	21	11,0	23,6
640	1220	600	50	-	RAL+TT	1458	744	-	1110	600	21	13,2	28,2
1800	500	50	460	500	RAL+TT	1606	819	-	360	1770	16	12,9	34,2
1800	580	50	540	580	RAL+TT	1623	828	-	440	1770	16	15,1	39,9
2000	500	50	460	500	RAL+TT	1556	794	-	360	1970	16	14,3	37,9
2000	580	50	540	580	RAL+TT	1774	905	-	440	1970	16	16,7	44,1

Radiator available in the following heights: 440, 540 and 640:

L6

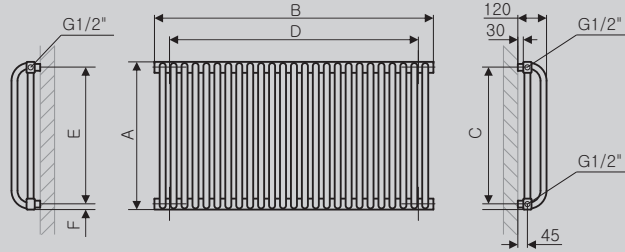

YL, VL

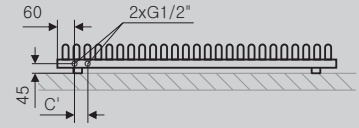

P3

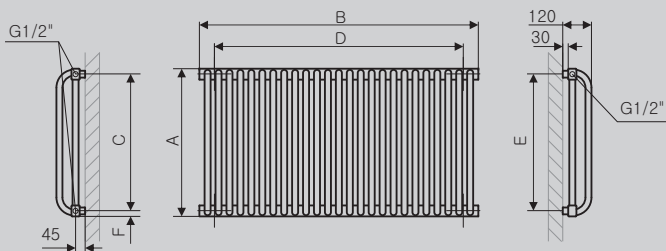

YP, VP

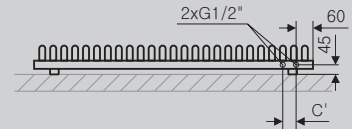

Radiator available in the following heights: 1800 and 2000:

P2

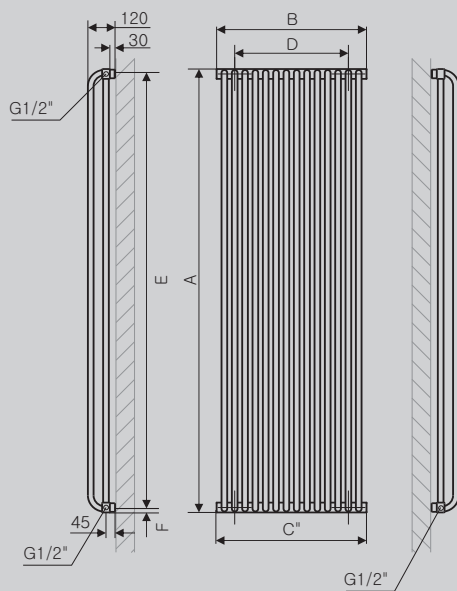

ZX

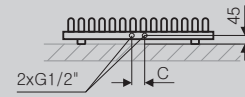

SX

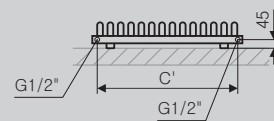

YL

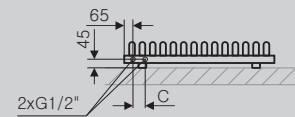

YP

