

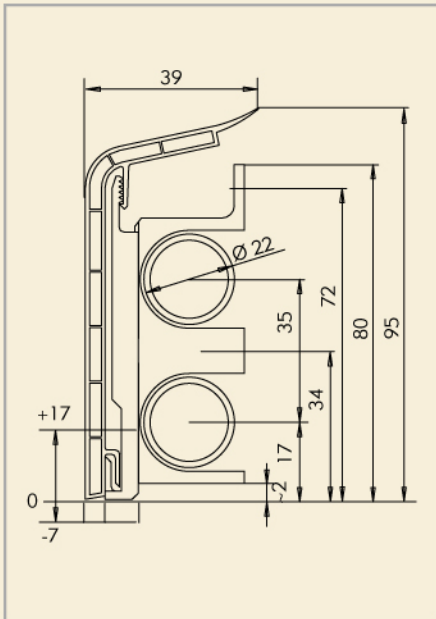

SLF 2000

The universal profile up to 22 mm in eight finishes

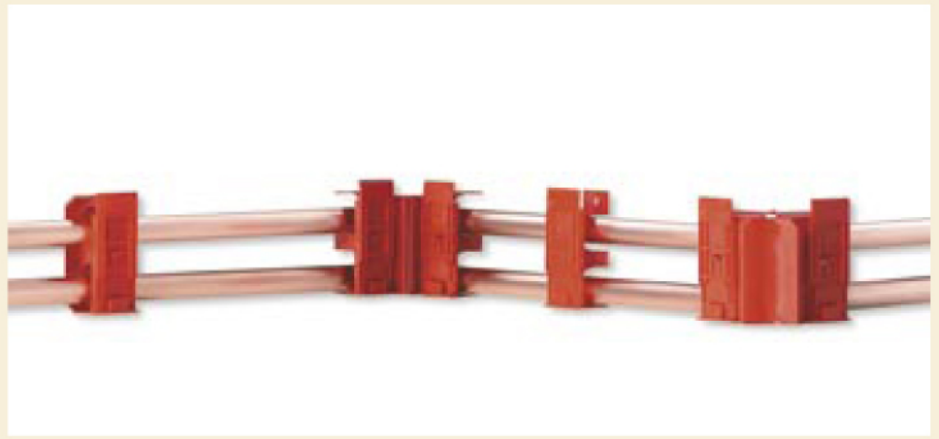

Dimensions of SLF 2000 profile, here with bracket 2150

The SLF 2000 profile is the universal skirting board profile for pipes up to 22 mm Ø. It is a robust plastic hollow space profile with a sealing lip on the wall in order to compensate for uneven walls. The outstanding feature of the profile's extremely durable material is its high impact resistance. Dummy skirting boards to match the SLF 2000 profile are available for walls without pipes (see page 18). The profile is attached after laying the pipes with the bracket art. no. 2150 or before laying pipes with bracket art. no. 2250.



The bracket art. no. 2250 is particularly well suited for uneven walls, damaged or soft plaster. We recommend spacing the brackets every 50 cm. If there are problems with the walls, space the brackets more closely together.

The brackets are attached with nail plug art. no. 208. For corner solutions there is a choice between the HZ 2000 corners and the corners for custom solutions. You will find assistance in choosing the right corner solution on pages 16 and 17.

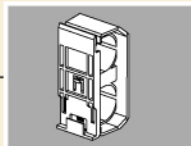

HZ bracket art. no. 2250 (SCH 2250)

Bracket for mounting under pipes prior to laying, up to 22 mm. Fits all HZ SLF 2000, HZ SLT 2000 and HZ SLL 2000 profiles. Packing unit: 40 pcs Number required: 2 per metre To ensure that mounting is not under any strain, we recommend positioning the bracket 1 – 3 mm from the floor.

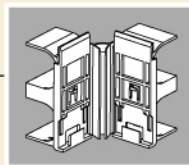

HZ bracket art. no. 2151 (IE SCH 2151)

Bracket for mounting over pipes after laying, up to 22 mm, for press-fit systems up to 18 mm. Only for use with IE 2000, IET 2000 and IEL 2000 in matching finish. Packing unit: 40 pcs Number required: 1 per inner corner

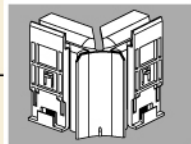

HZ bracket art. no. 2152 (IE SCH 2152)

Bracket for mounting over the pipes after laying, up to 22 mm, for press-fit systems up to 18 mm. Only for use with AE 2000, AET 2000 and AEL 2000 in matching finish. Packing unit: 40 pcs Number required: 1 per outer corner



Nail plug art. no. 208 (ND 80-8)

Wall plug with countersunk head and threaded nail. Packing unit: 50 pcs Requirements: 1 per bracket, 2 per corner bracket Please use article 204 to provide the bracket 2150 with additional fastening!



Nail plug art. no. 204 (ND 40-6)

Wall plug with countersunk head and threaded nail. Packing unit: 50 pcs Requirements: 1 pce. to provide the bracket 2150 with additional fastening.



Screw plug art. no. 209 (DHB 80-8)

Screw plug for hollow block & Rigips (plasterboard) walls Packing unit: 50 pcs Number required: 1 per bracket, 2 per corner bracket Note: Torx contour



 When using the HZ 2000 inner corner you need an inner corner bracket (art. no. 2151), when using the HZ 2000 outer corner an outer corner bracket is needed (art. no. 2152). When cutting the skirting board profile to size, remember that for each inner corner bracket used the profile has to be shortened by 45 mm.





The corner brackets provide solid support for the profile and the corner moulded parts and no mitre cut is needed. This saves valuable time in installation. The profile is pressed against the wall and pushed down into the brackets. The inner and outer corners are slid over the square-cut skirting boards onto the corner brackets.

With the SLF 2000 profile you can choose from eight finishes and matching moulded parts.

Together with the HZ radiator connections you can achieve a technically sophisticated solution and an attractive appearance.

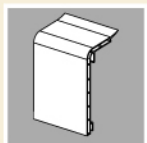
With very uneven walls and floors we recommend using an additional sealing lip which can be stuck on (see page 20).

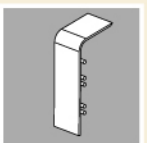
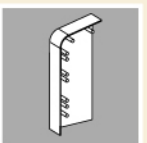
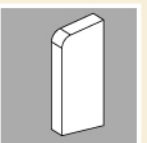
SLF 2000 profile	Inside corner	Outside corner	Butt joint	Left end piece	Right end piece	Inner corner for custom solutions	Outer corner for custom solutions
Skirting board made of plastic hollow space profile Packing unit: 40 m Length: 4 m	IMPORTANT: Only for use in combination with IE SCH 2151 Packing unit: 10 pcs	IMPORTANT: Only for use in combination with AE SCH 2152 Packing unit: 10 pcs	Packing unit: 10 pcs Same article also for BLF, see page 18	Packing unit: 10 pcs Same article also for BLF, see page 18	Packing unit: 10 pcs Same article also for BLF, see page 18	For working without inner corner brackets, (also for BLF or transition piece from BLF to SLF) Packing unit: 10 pcs	For working without outer corner brackets, (also for BLF or transition piece from BLF to SLF) Packing unit: 10 pcs

							
Maple Art. no. 2010 (SLF 2000 A)	Maple Art. no. 2011 (IE 2000 A)	Maple Art. no. 2012 (AE 2000 A)	Maple Art. no. 2013 (ST A)	Maple Art. no. 2014 (ES A left)	Maple Art. no. 2015 (ES A right)	Maple Art. no. 2016 (IE A)	Maple Art. no. 2017 (AE A)
Light beech Art. no. 2020 (SLF 2000 BH)	Light beech Art. no. 2021 (IE 2000 BH)	Light beech Art. no. 2022 (AE 2000 BH)	Light beech Art. no. 2023 (ST BH)	Light beech Art. no. 2024 (ES BH left)	Light beech Art. no. 2025 (ES BH right)	Light beech Art. no. 2026 (IE BH)	Light beech Art. no. 2027 (AE BH)
Dark beech Art. no. 2030 (SLF 2000 BD)	Dark beech Art. no. 2031 (IE 2000 BD)	Dark beech Art. no. 2032 (AE 2000 BD)	Dark beech Art. no. 4133 (ST BD)	Dark beech Art. no. 4134 (ES BD left)	Dark beech Art. no. 4135 (ES BD right)	Dark beech Art. no. 4131 (IE BD)	Dark beech Art. no. 4132 (AE BD)
White ash Art. no. 2040 (SLF 2000 EW)	White ash Art. no. 2041 (IE 2000 EW)	White ash Art. no. 2042 (AE 2000 EW)	White ash Art. no. 4143 (ST EW)	White ash Art. no. 4144 (ES EW left)	White ash Art. no. 4145 (ES EW right)	White ash Art. no. 4141 (IE EW)	White ash Art. no. 4142 (AE EW)
Light oak Art. no. 2060 (SLF 2000 EH)	Light oak Art. no. 2061 (IE 2000 EH)	Light oak Art. no. 2062 (AE 2000 EH)	Light oak Art. no. 163 (ST EH)	Light oak Art. no. 164 (ES EH left)	Light oak Art. no. 165 (ES EH right)	Light oak Art. no. 161 (IE EH)	Light oak Art. no. 162 (AE EH)
Dark oak Art. no. 2070 (SLF 2000 ED)	Dark oak Art. no. 2071 (IE 2000 ED)	Dark oak Art. no. 2072 (AE 2000 ED)	Dark oak Art. no. 173 (ST ED)	Dark oak Art. no. 174 (ES ED left)	Dark oak Art. no. 175 (ES ED right)	Dark oak Art. no. 171 (IE ED)	Dark oak Art. no. 172 (AE ED)
White Art. no. 2080 (SLF 2000 W)	White Art. no. 2081 (IE 2000 W)	White Art. no. 2082 (AE 2000 W)	White Art. no. 183 (ST W)	White Art. no. 184 (ES W left)	White Art. no. 185 (ES W right)	White Art. no. 181 (IE W)	White Art. no. 182 (AE W)
Grey Art. no. 2090 (SLF 2000 G)	Grey Art. no. 2091 (IE 2000 G)	Grey Art. no. 2092 (AE 2000 G)	Grey Art. no. 193 (ST G)	Grey Art. no. 194 (ES G left)	Grey Art. no. 195 (ES G right)	Grey Art. no. 191 (IE G)	Grey Art. no. 192 (AE G)